

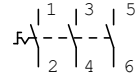



	Sectionneur		Interrupteur 3 pôles
	Disjoncteur 2 pôles		DDR 2 pôles
	Disjoncteur 4 pôles		DDR 4 pôles
	Contacteur 230V		Contact NO
	Picofi 4 pôles		Horloge
	Borne		

F	D	Correction dispo	10.02.22	MAG	Date	10.02.2022	Meyrin - Agilent	Tabelco SA Rue Pierre Yerly 4	Légende	TS010.1	=	F
B	Modification	04.02.22		Resp.	MAG					+		
C	Modification	08.02.22		Vérif.			1762 Givisiez			Folio 2		
Vers.	Modificat.	Date	Nom	Norme	Origine	Remplace:	Remplacé par:			de 113Fol		

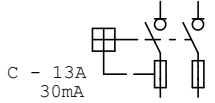
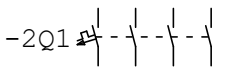
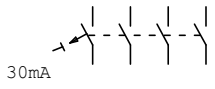

Alimentation
Resau normal
63A

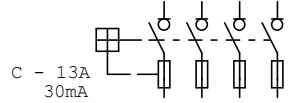
Parafoudre

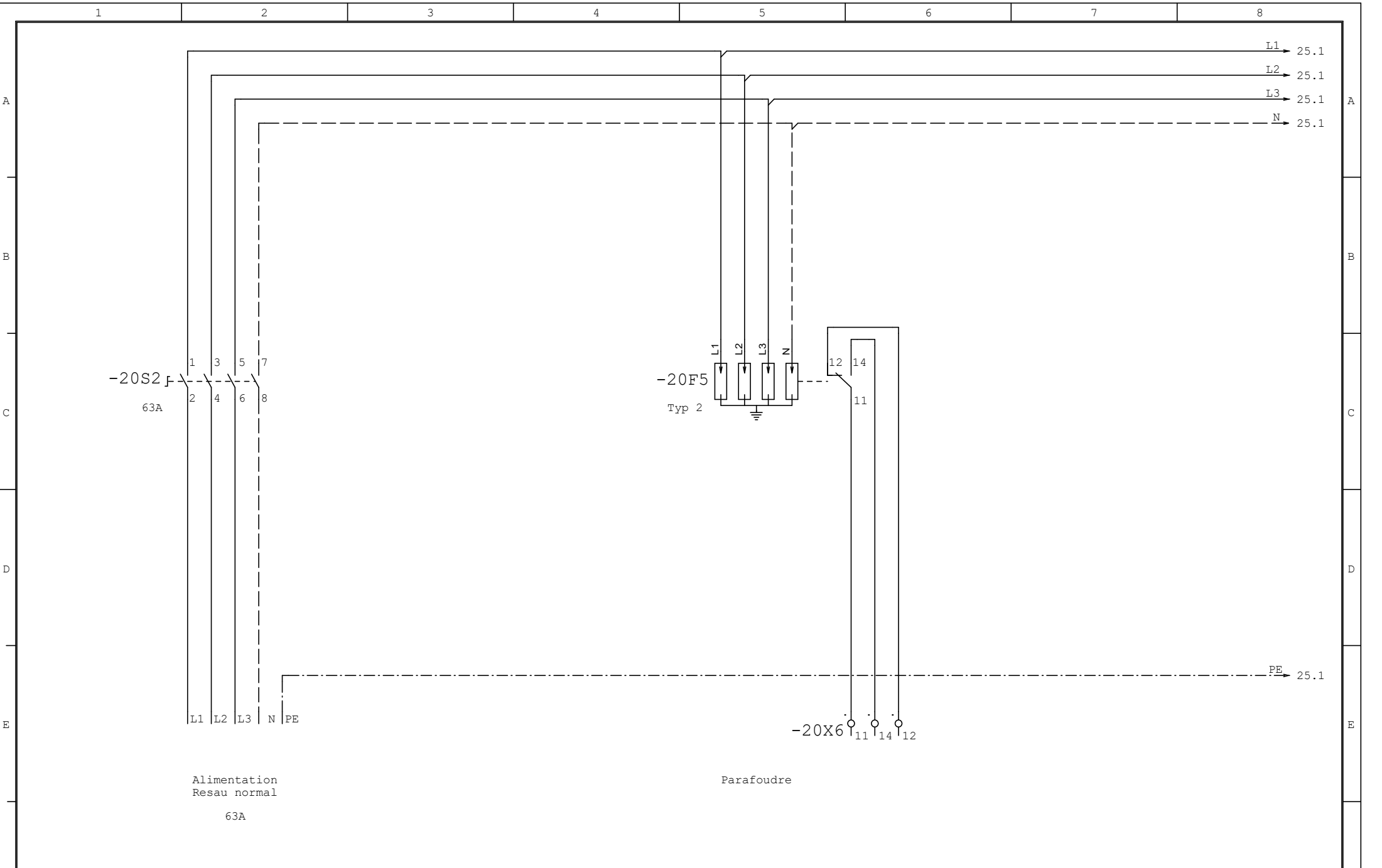
D	Correction dispo	10.02.22	MAG	Date	10.02.2022	Meyrin - Agilent	Tabelco SA	Alimentation	TS010.1	=
B	Modification	04.02.22		Resp.	MAG		Rue Pierre Yerly 4			+
C	Modification	08.02.22		Vérif.			1762 Givisiez			
Vers.	Modificat.	Date	Nom	Norme		Origine	Remplace:	Remplacé par:		Folio 20
										de 113Fol

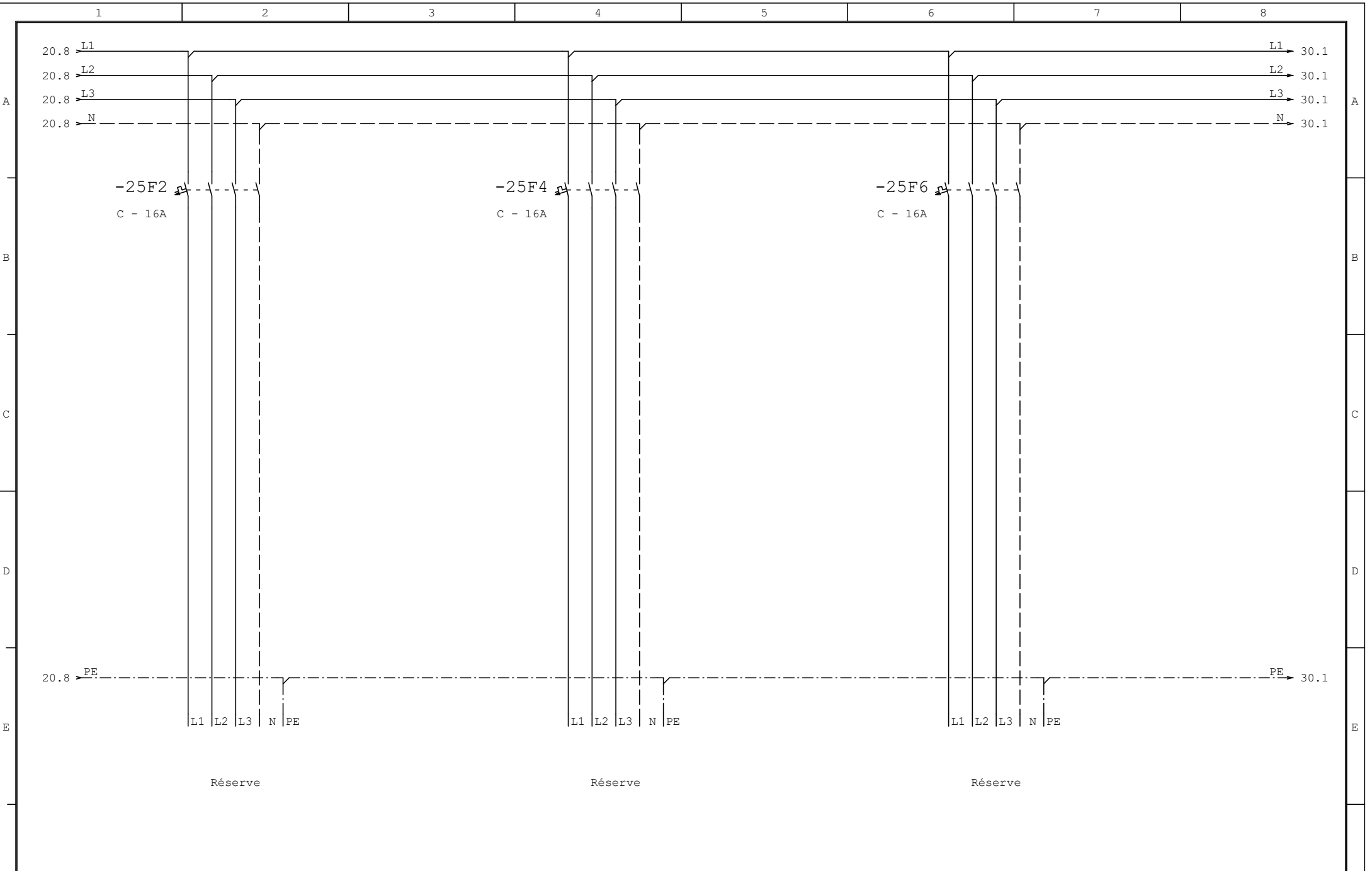

D	Correction dispo	10.02.22	MAG	Date	10.02.2022	Meyrin - Agilent	Tabelco SA	Alimentation	TS010.1	=	
B	Modification	04.02.22		Resp.	MAG		Rue Pierre Yerly 4			+	
C	Modification	08.02.22		Vérif.			1762 Givisiez				Folio 25
Vers.	Modificat.	Date	Nom	Norme		Origine	Remplace:	Remplacé par:			de 113Fol

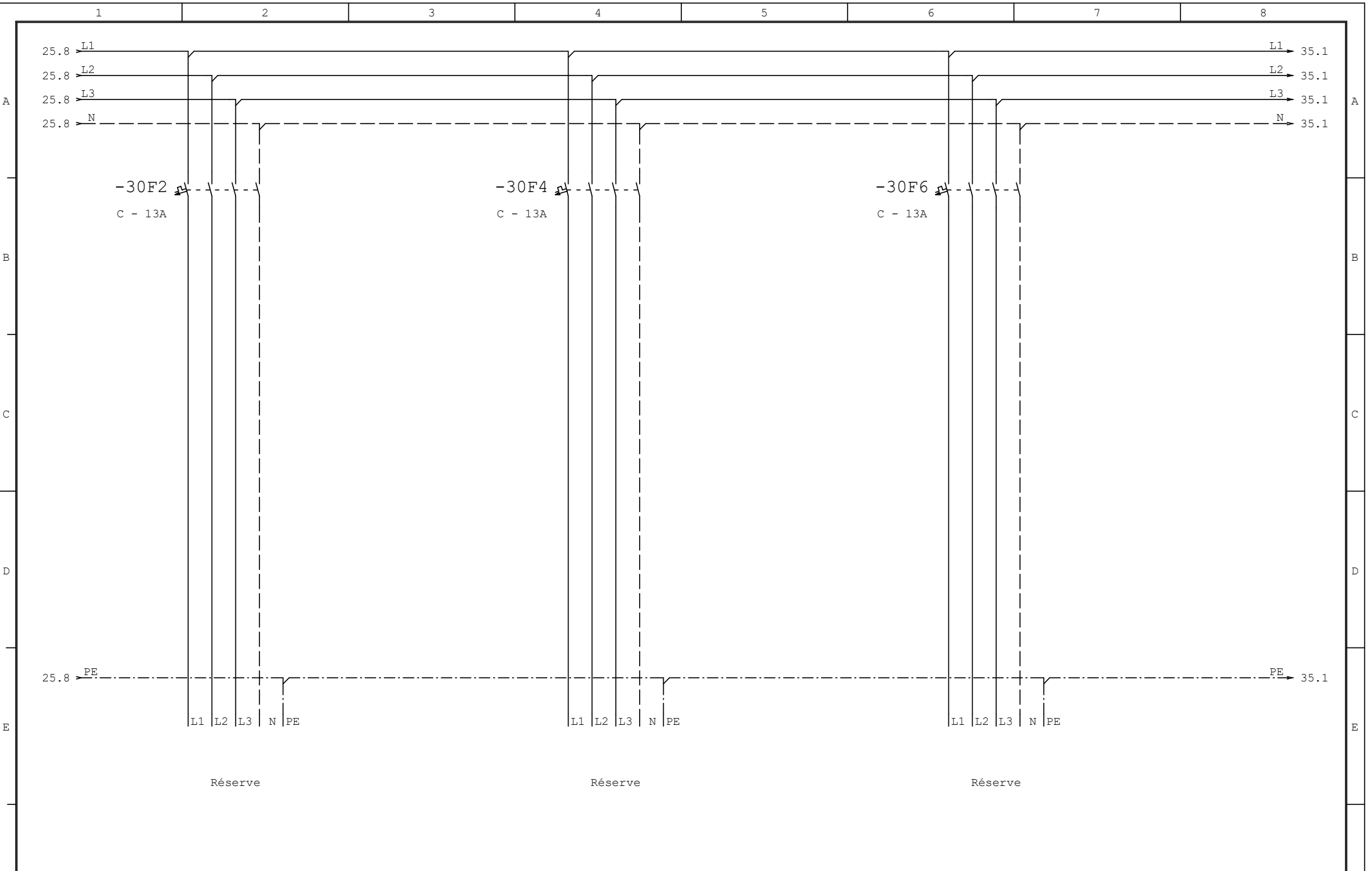

D	Correction dispo	10.02.22	MAG	Date	10.02.2022	Meyrin - Agilent	Tabelco SA	Alimentation	TS010.1	=	
B	Modification	04.02.22		Resp.	MAG		Rue Pierre Yerly 4			+	
C	Modification	08.02.22		Vérif.			1762 Givisiez				Folio 30
Vers.	Modificat.	Date	Nom	Norme		Origine	Remplace:	Remplacé par:			de 113Fol
1	2	3	4	5	6	7	8				

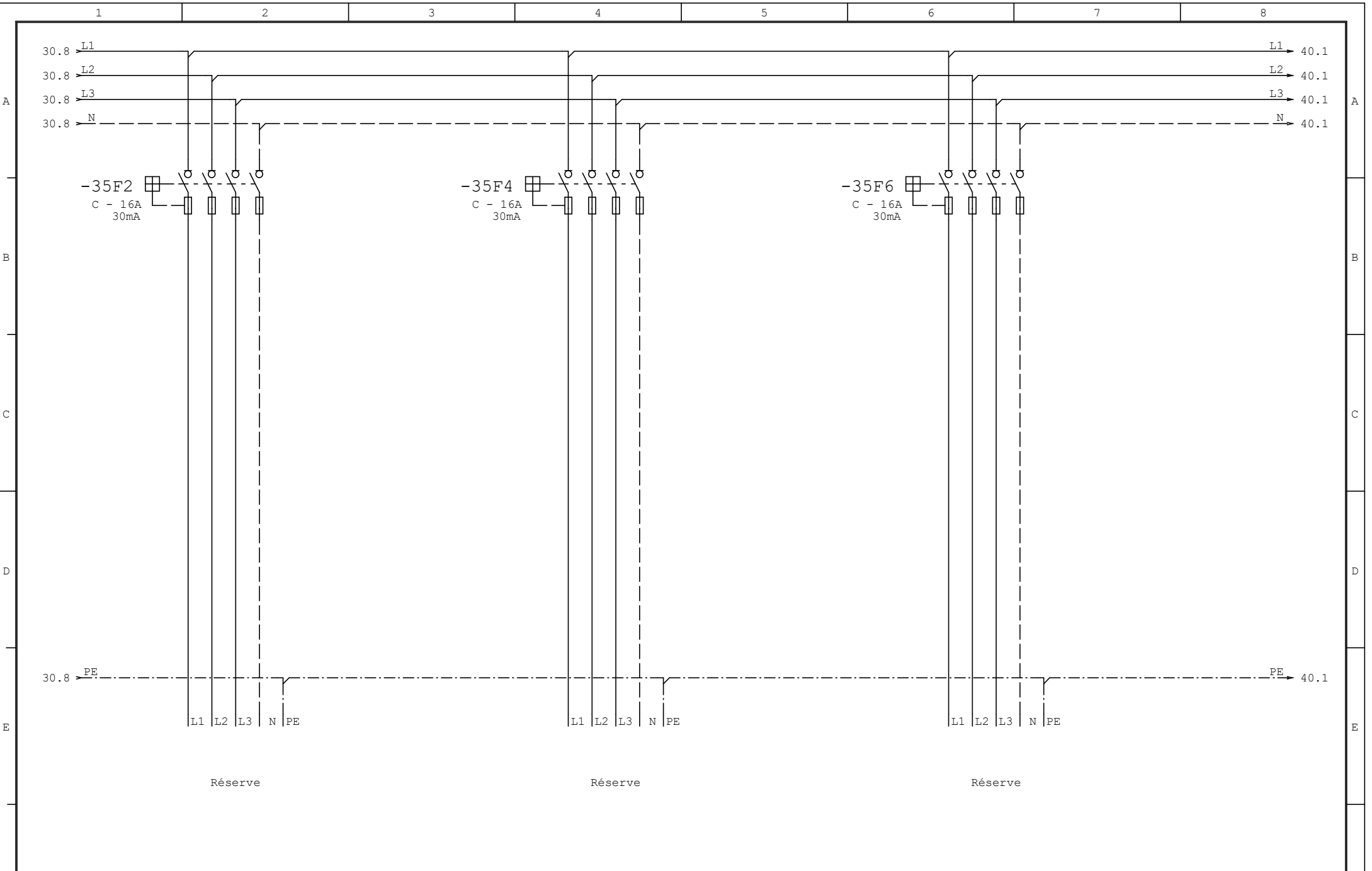

D	Correction dispo	10.02.22	MAG	Date	10.02.2022	Meyrin - Agilent	Tabelco SA	Alimentation	TS010.1	=		
B	Modification	04.02.22		Resp.	MAG		Rue Pierre Yerly 4				+	
C	Modification	08.02.22		Vérif.			1762 Givisiez					Folio 35
Vers.	Modificat.	Date	Nom	Norme		Origine	Remplace:	Remplacé par:			de 113Fol	

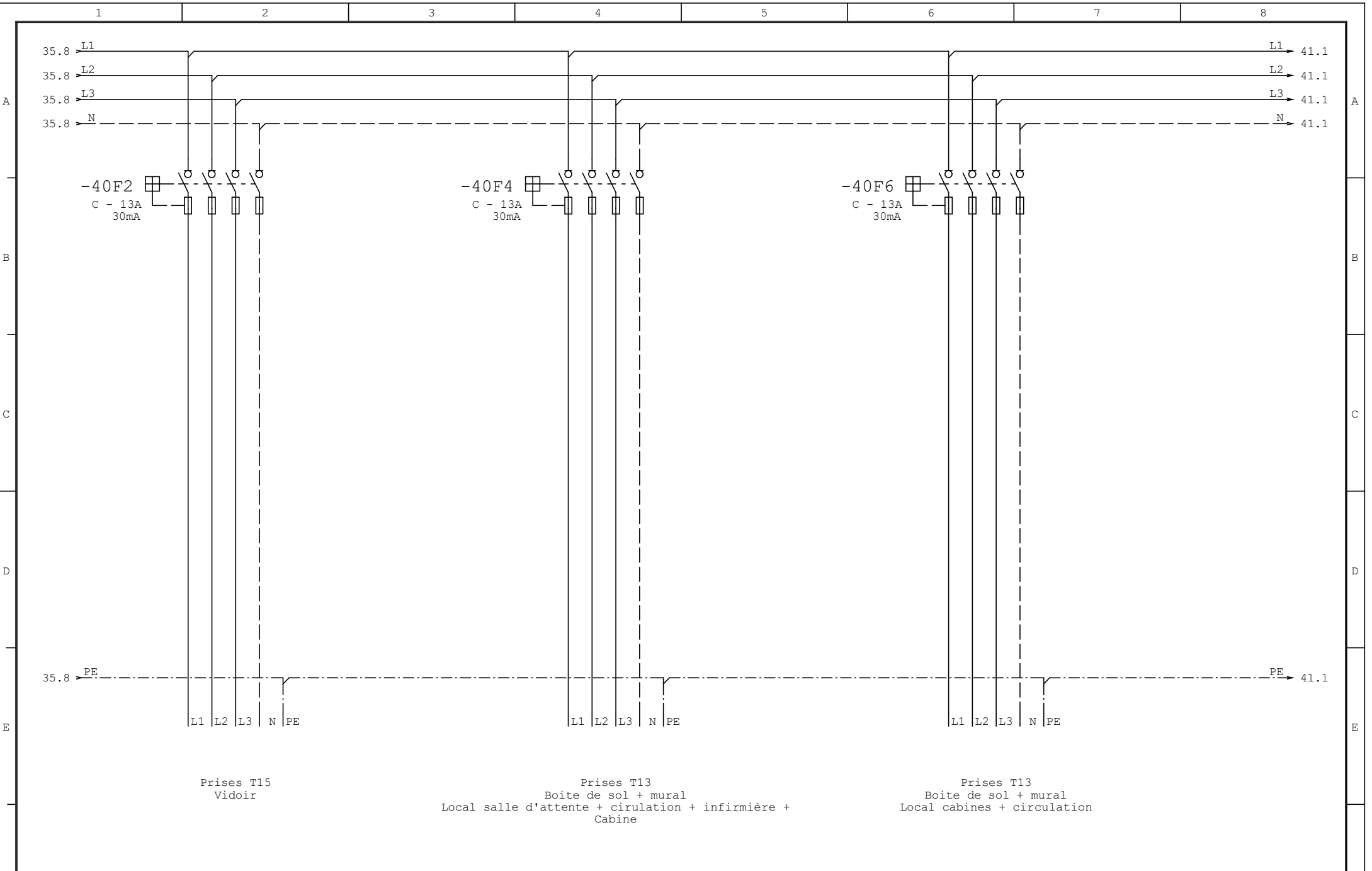

D	Correction dispo	10.02.22	MAG	Date	10.02.2022	Meyrin - Agilent	Tabelco SA	Alimentation	TS010.1	=		
B	Modification	04.02.22		Resp.	MAG		Rue Pierre Yerly 4				+	
C	Modification	08.02.22		Vérif.			1762 Givisiez					Folio 40
Vers.	Modificat.	Date	Nom	Norme		Origine	Remplace:	Remplacé par:			de 113Fol	
1	2	3	4	5	6	7	8					

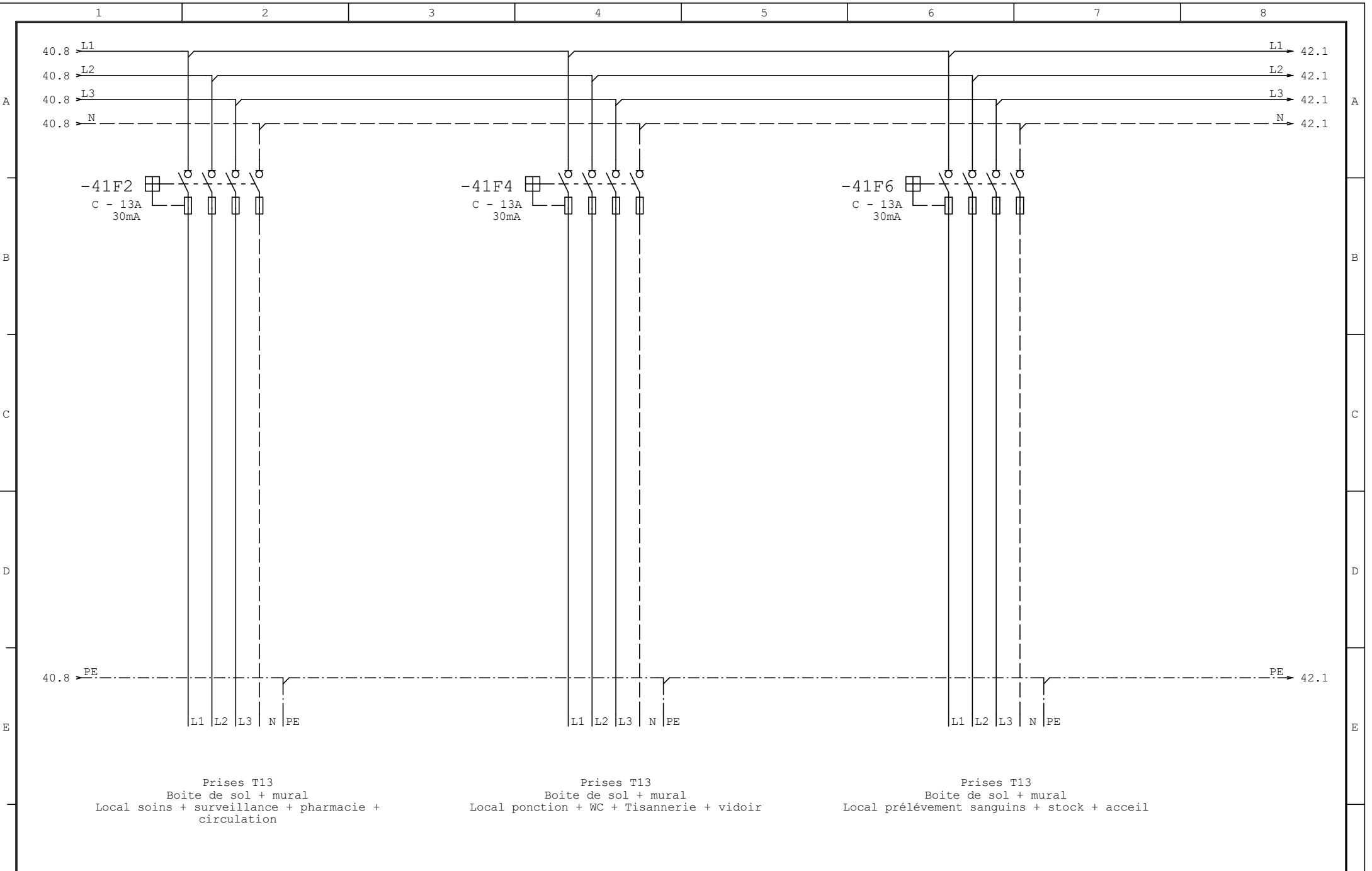

D	Correction dispo	10.02.22	MAG	Date	10.02.2022	Meyrin - Agilent	Tabelco SA	Alimentation	TS010.1	=		
B	Modification	04.02.22		Resp.	MAG		Rue Pierre Yerly 4				+	
C	Modification	08.02.22		Vérif.			1762 Givisiez					Folio 41
Vers.	Modificat.	Date	Nom	Norme		Origine	Remplace:	Remplacé par:			de 113Fol	
1	2	3	4	5	6	7	8					

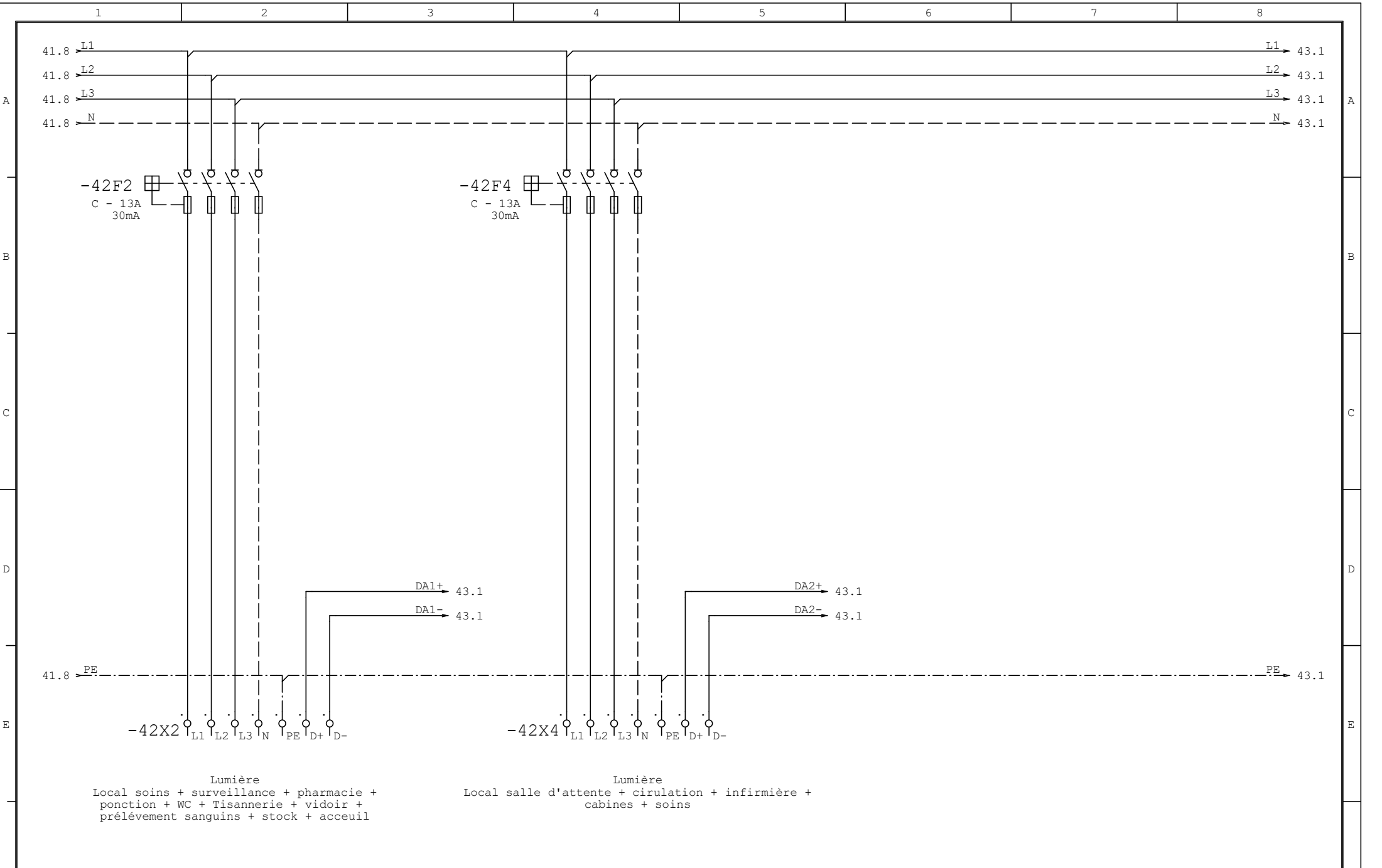

D	Correction dispo	10.02.22	MAG	Date	10.02.2022	Meyrin - Agilent	Tabelco SA	Alimentation	TS010.1	=
B	Modification	04.02.22		Resp.	MAG		Rue Pierre Yerly 4			
C	Modification	08.02.22		Vérif.			1762 Givisiez			
Vers.	Modificat.	Date	Nom	Norme		Origine	Remplace:	Remplacé par:		Folio 42

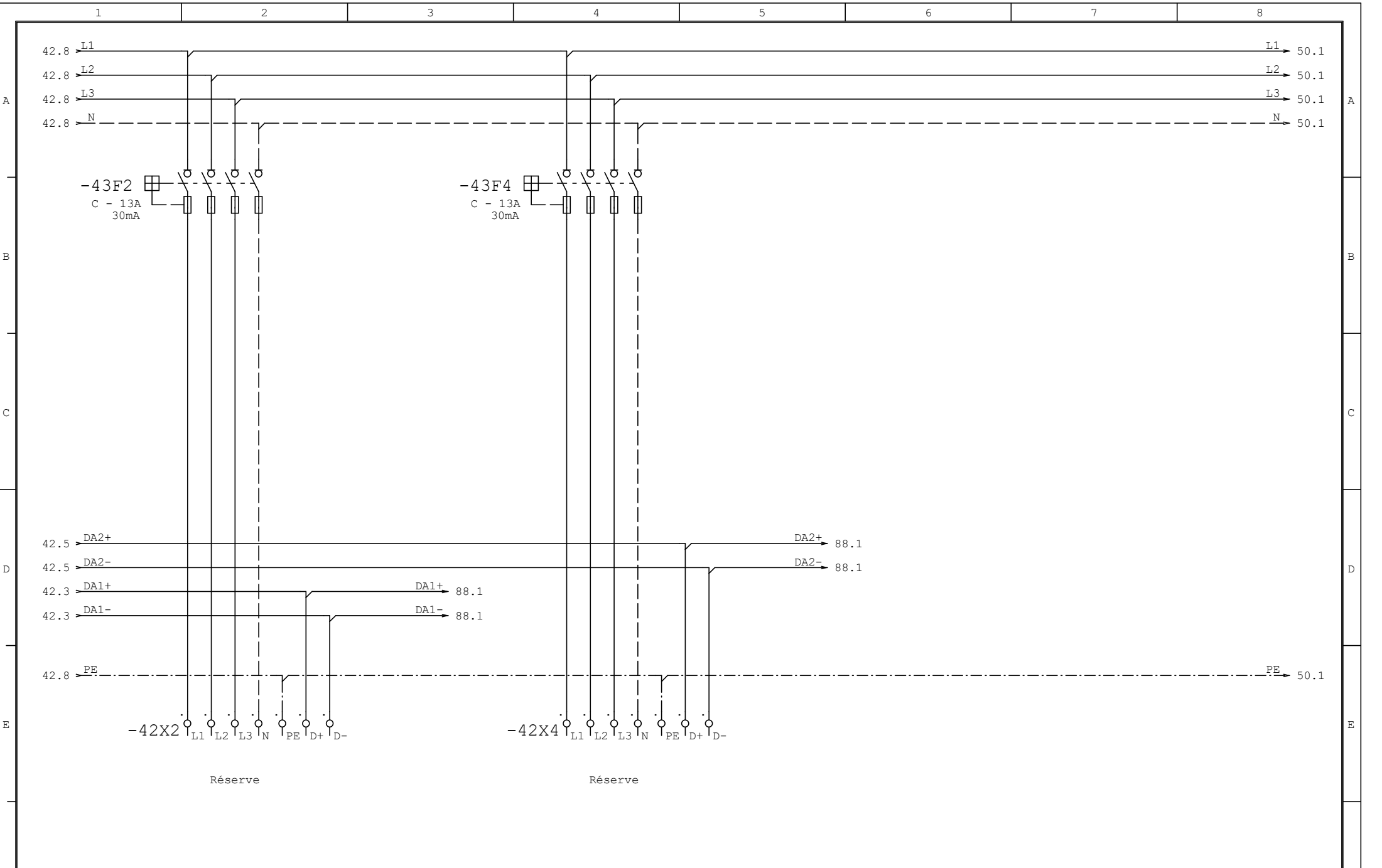

D	Correction dispo	10.02.22	MAG	Date	10.02.2022	Meyrin - Agilent	Tabelco SA	Alimentation	TS010.1	=	
B	Modification	04.02.22		Resp.	MAG		Rue Pierre Yerly 4				+
C	Modification	08.02.22		Vérif.			1762 Givisiez				
Vers.	Modificat.	Date	Nom	Norme		Origine	Remplace:	Remplacé par:		Folio 43	

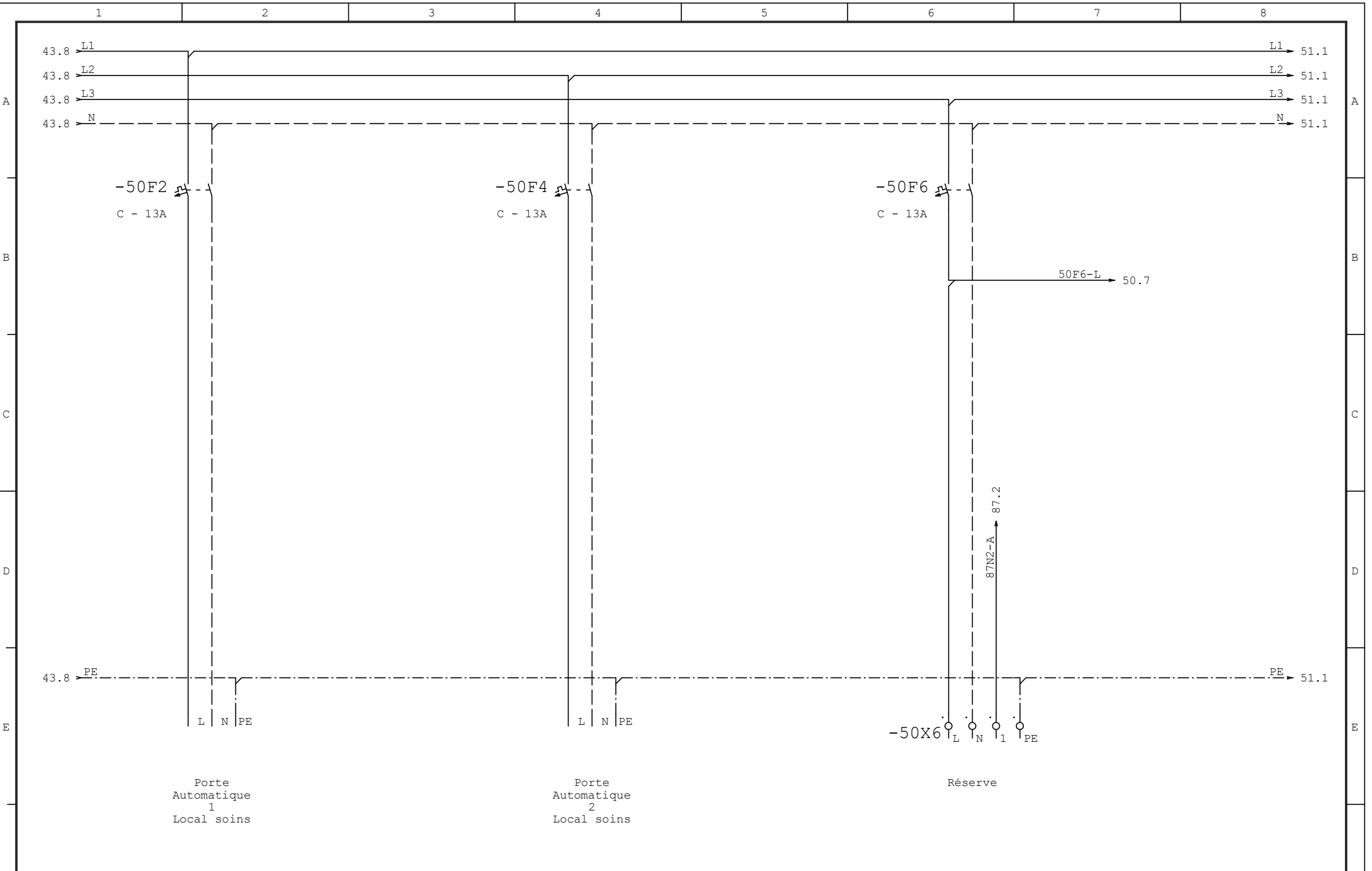

D	Correction dispo	10.02.22	MAG	Date	10.02.2022	Meyrin - Agilent	Tabelco SA			=	
B	Modification	04.02.22		Resp.	MAG		Rue Pierre Yerly 4			+	
C	Modification	08.02.22		Vérif.			1762 Givisiez				Folio 50
Vers.	Modificat.	Date	Nom	Norme		Origine	Remplace:	Remplacé par:			de 113Fol



D	Correction dispo	10.02.22	MAG	Date	10.02.2022	Meyrin - Agilent		Tabelco SA		=	
B	Modification	04.02.22		Resp.	MAG			Rue Pierre Yerly 4		TS010.1	
C	Modification	08.02.22		Vérif.				1762 Givisiez		Folio 51	
Vers.	Modificat.	Date	Nom	Norme		Origine	Remplace:	Remplacé par:		de 113Fol	

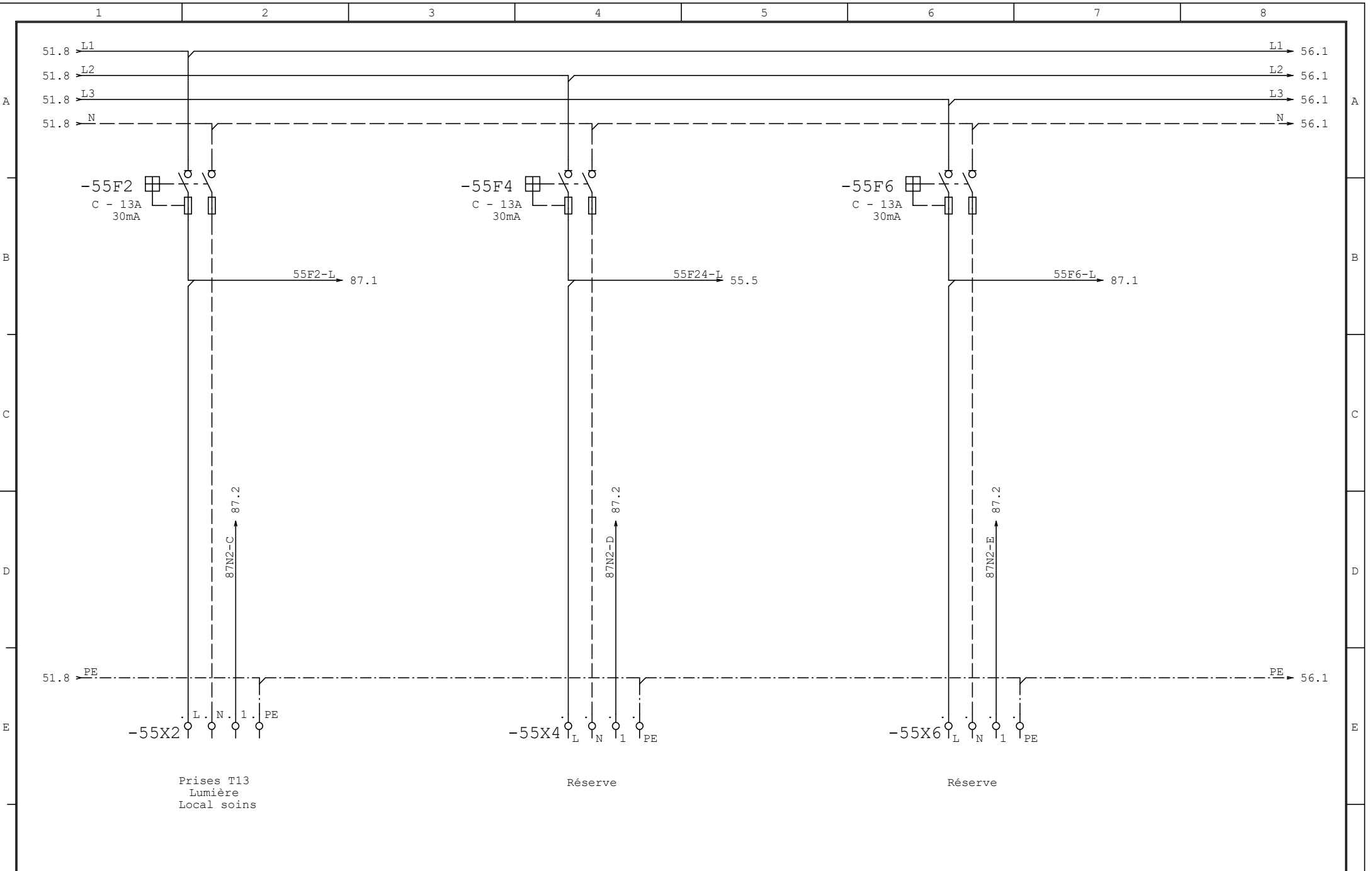

D	Correction dispo	10.02.22	MAG	Date	10.02.2022	Meyrin - Agilent	Tabelco SA	=	
B	Modification	04.02.22		Resp.	MAG		Rue Pierre Yerly 4	+	
C	Modification	08.02.22		Vérif.			1762 Givisiez	Folio 55	
Vers.	Modificat.	Date	Nom	Norme		Origine	Remplace:	Remplacé par:	
1	2	3	4	5	6	7	8	de 113Fol	

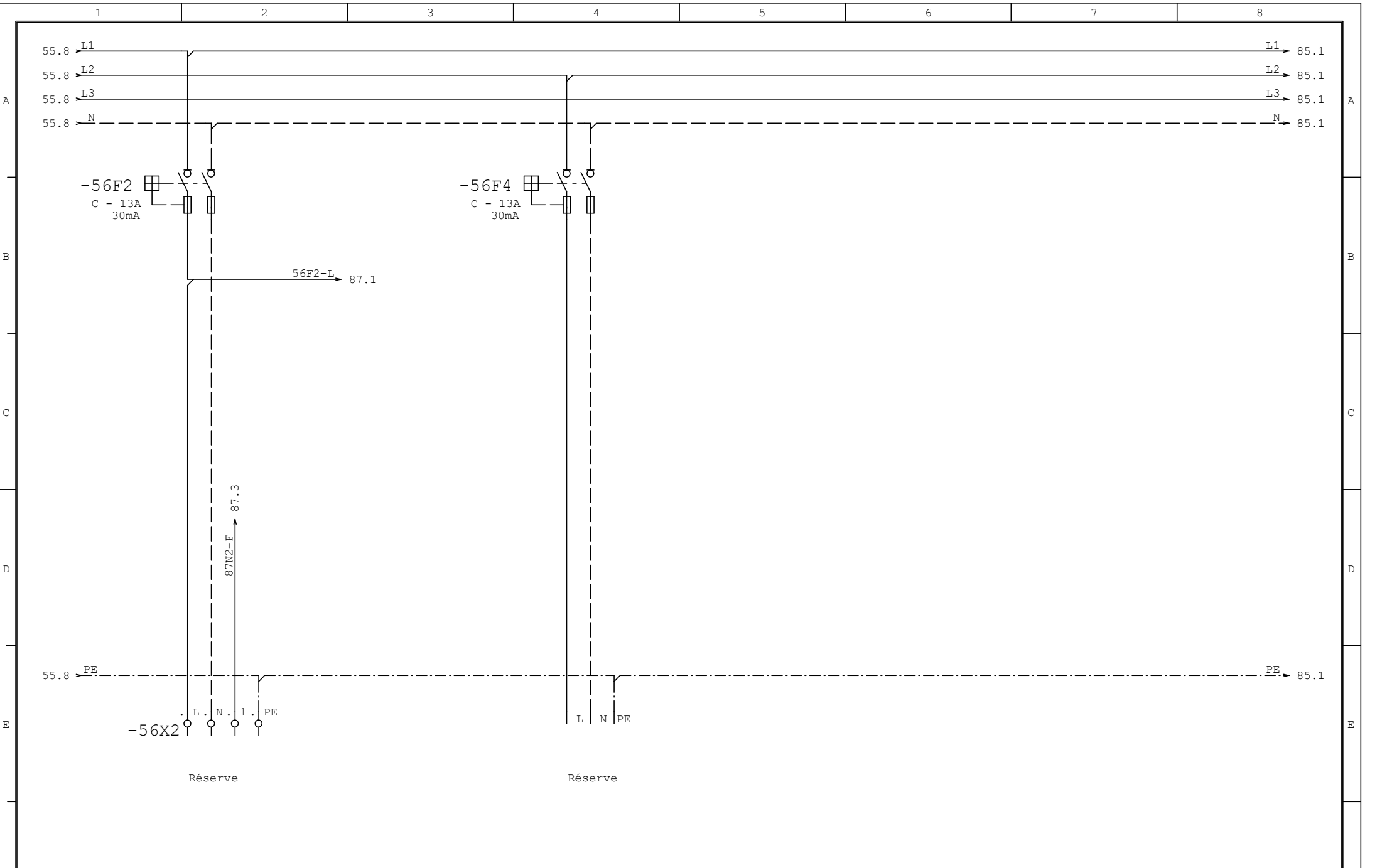

D	Correction dispo	10.02.22	MAG	Date	10.02.2022	Meyrin - Agilent	Tabelco SA			=
B	Modification	04.02.22		Resp.	MAG		Rue Pierre Yerly 4			+
C	Modification	08.02.22		Vérif.			1762 Givisiez			
Vers.	Modificat.	Date	Nom	Norme		Origine	Remplace:	Remplacé par:		Folio 56
										de 113Fol

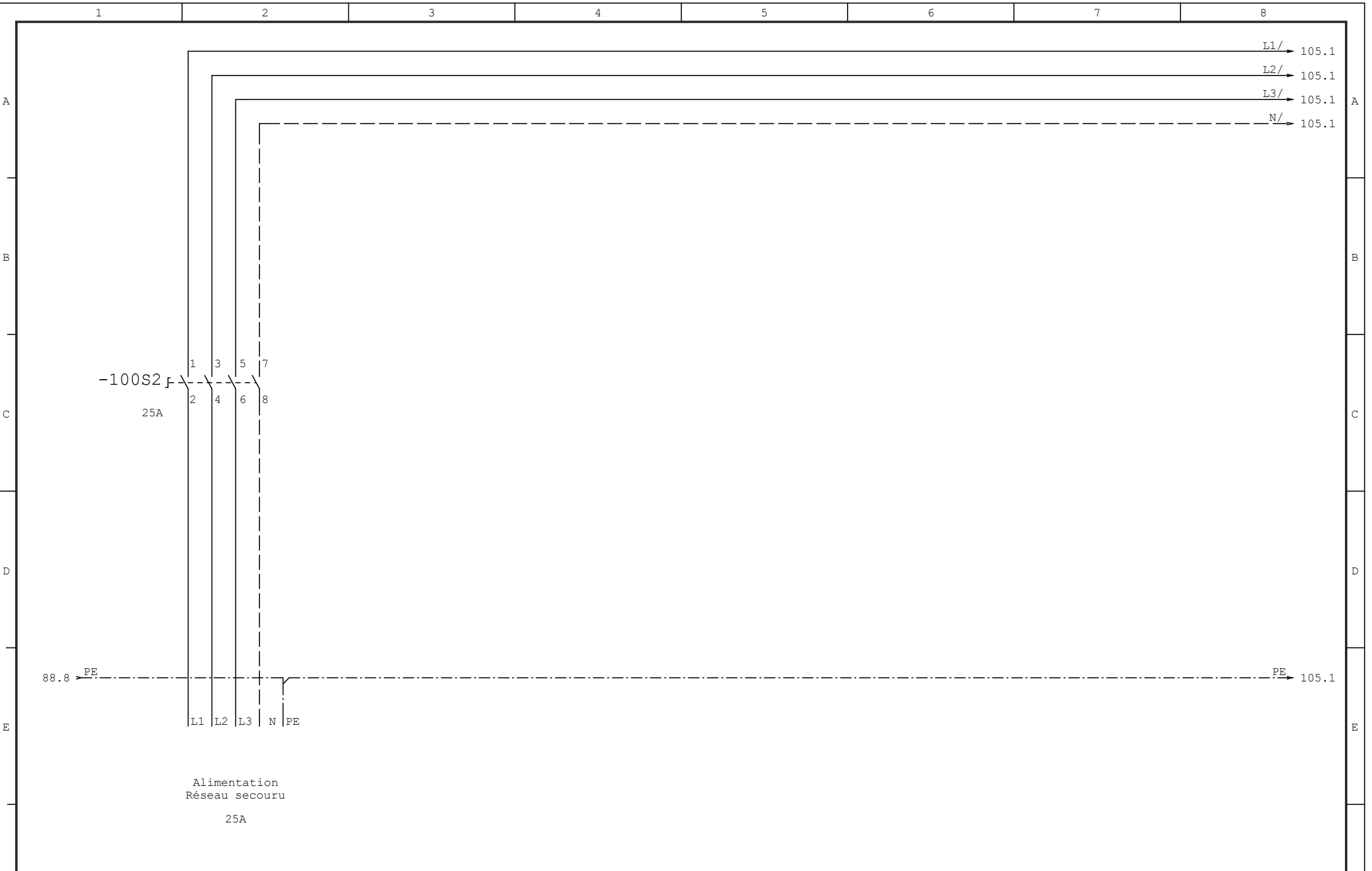

Alimentation
Réseau secouru
25A

D	Correction dispo	10.02.22	MAG	Date	10.02.2022	Meyrin - Agilent	Tabelco SA Rue Pierre Yerly 4	Alimentation	TS010.1	=	
B	Modification	04.02.22		Resp.	MAG					+	
C	Modification	08.02.22		Vérif.			1762 Givisiez				Folio 100
Vers.	Modificat.	Date	Nom	Norme		Origine	Remplace:	Remplacé par:			de 113Fol

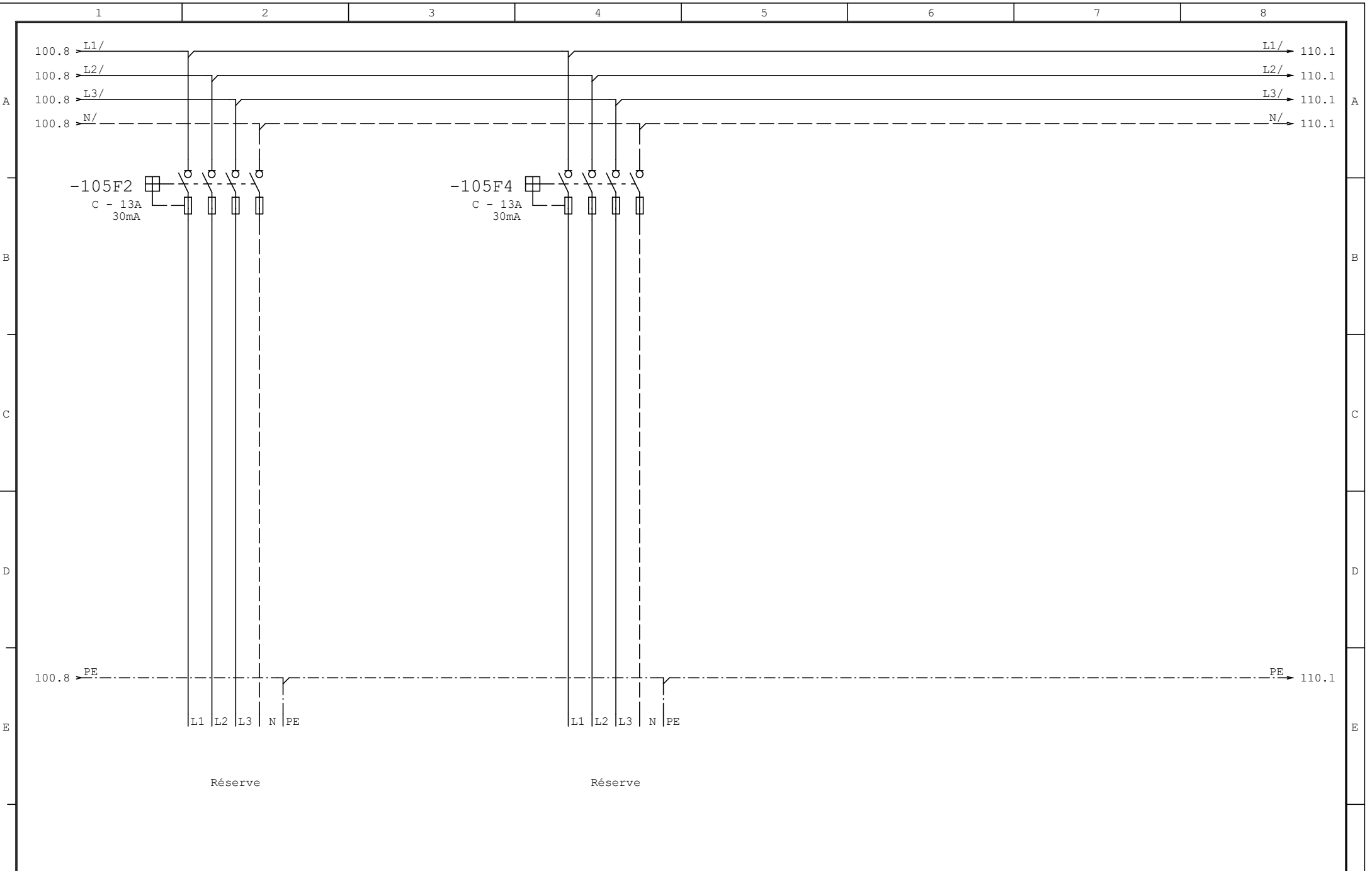

D	Correction dispo	10.02.22	MAG	Date	10.02.2022	Meyrin - Agilent	Tabelco SA	Alimentation	TS010.1	=		
B	Modification	04.02.22		Resp.	MAG		Rue Pierre Yerly 4				+	
C	Modification	08.02.22		Vérif.			1762 Givisiez					Folio 105
Vers.	Modificat.	Date	Nom	Norme		Origine	Remplace:	Remplacé par:			de 113Fol	

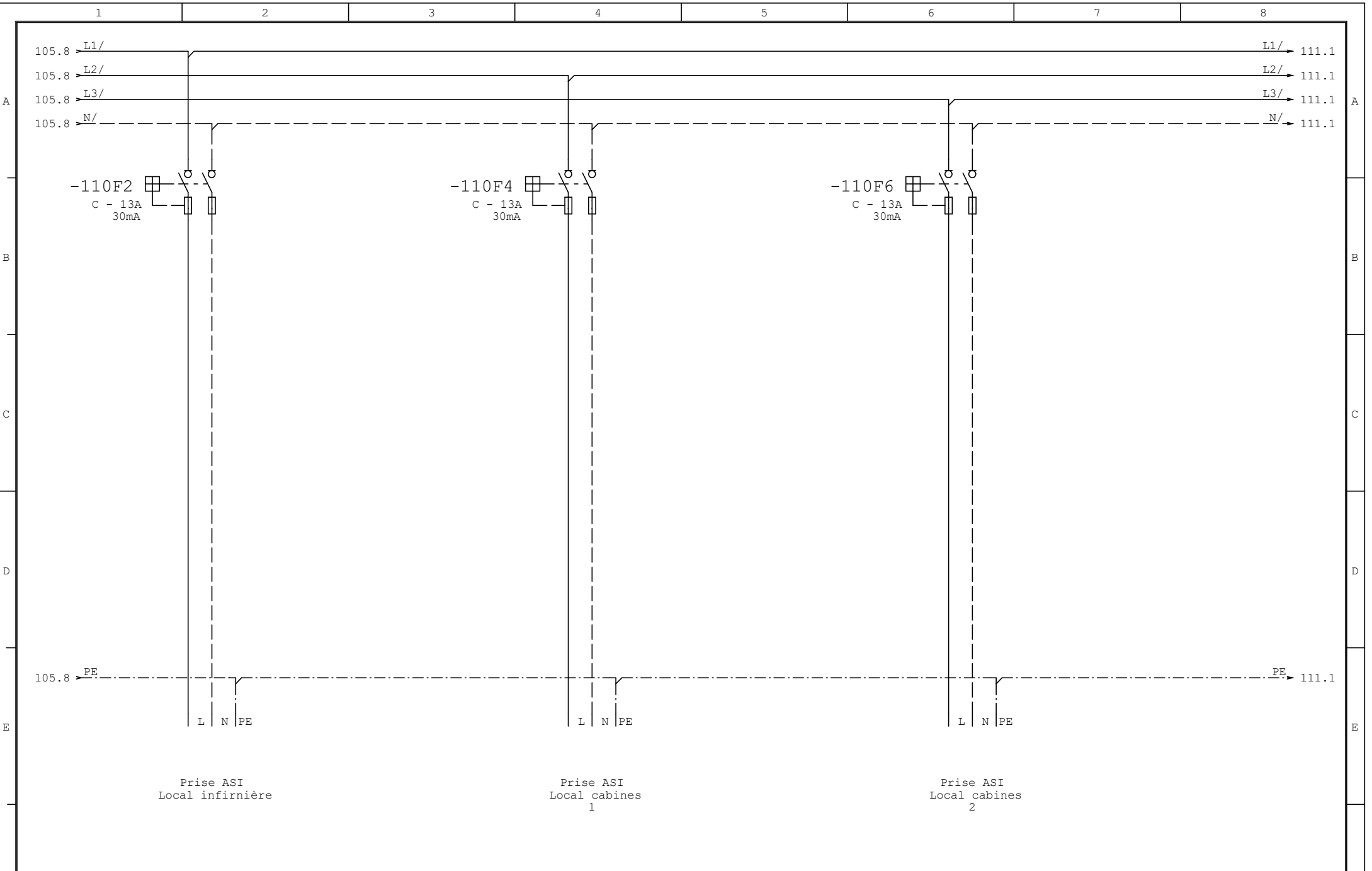

D	Correction dispo	10.02.22	MAG	Date	10.02.2022	Meyrin - Agilent	Tabelco SA			=	
B	Modification	04.02.22		Resp.	MAG		Rue Pierre Yerly 4			+	
C	Modification	08.02.22		Vérif.			1762 Givisiez				Folio 110
Vers.	Modificat.	Date	Nom	Norme		Origine	Remplace:	Remplacé par:			de 113Fol

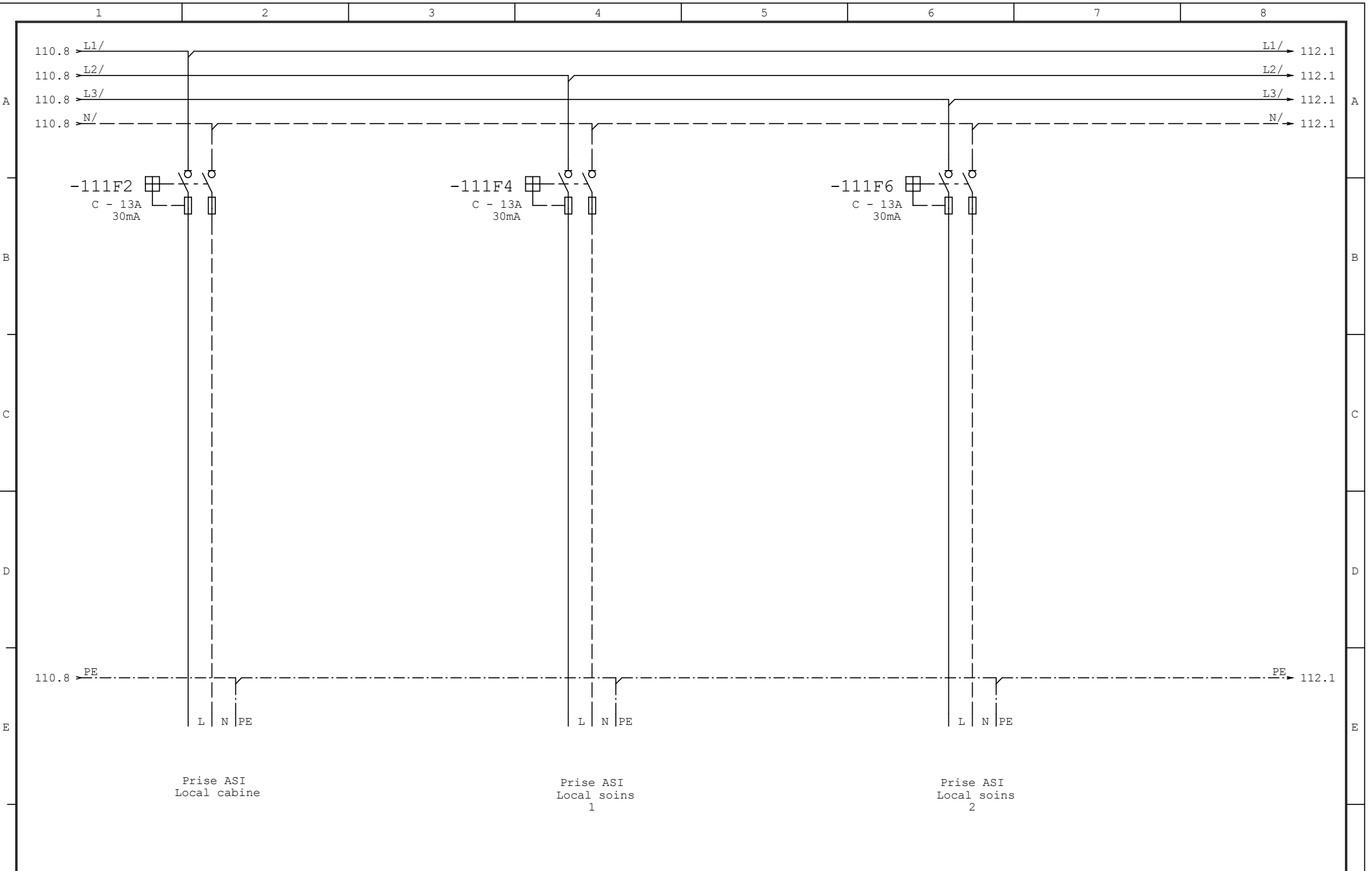

D	Correction dispo	10.02.22	MAG	Date	10.02.2022	Meyrin - Agilent	Tabelco SA			=
B	Modification	04.02.22		Resp.	MAG		Rue Pierre Yerly 4			+
C	Modification	08.02.22		Vérif.			1762 Givisiez			Folio 111
Vers.	Modificat.	Date	Nom	Norme		Origine	Remplace:	Remplacé par:	de 113Fol	

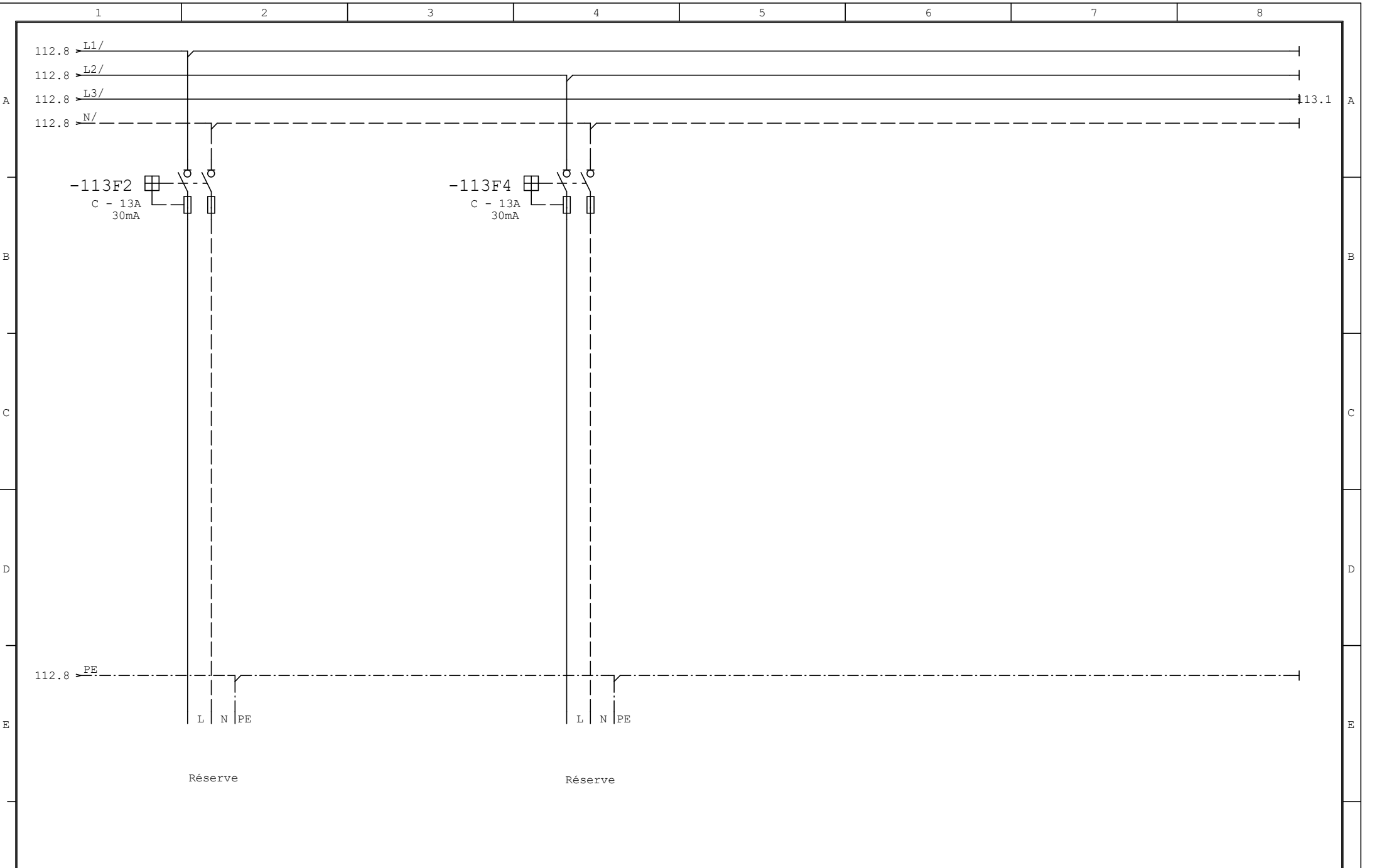

D	Correction dispo	10.02.22	MAG	Date	10.02.2022	Meyrin - Agilent	Tabelco SA			=
B	Modification	04.02.22		Resp.	MAG		Rue Pierre Yerly 4			+
C	Modification	08.02.22		Vérif.			1762 Givisiez			
Vers.	Modificat.	Date	Nom	Norme		Origine	Remplace:	Remplacé par:		Folio 113
										de 113Fol

Alimentation depuis en haut
 Départ vers le haut
 PVC IP2x

Armoire Almatec AN60
 IP40
 RAL7035
 Porte pleine
 Charnières double
 Profondeur 300 et sans socle
 Fixation directement contre le mur

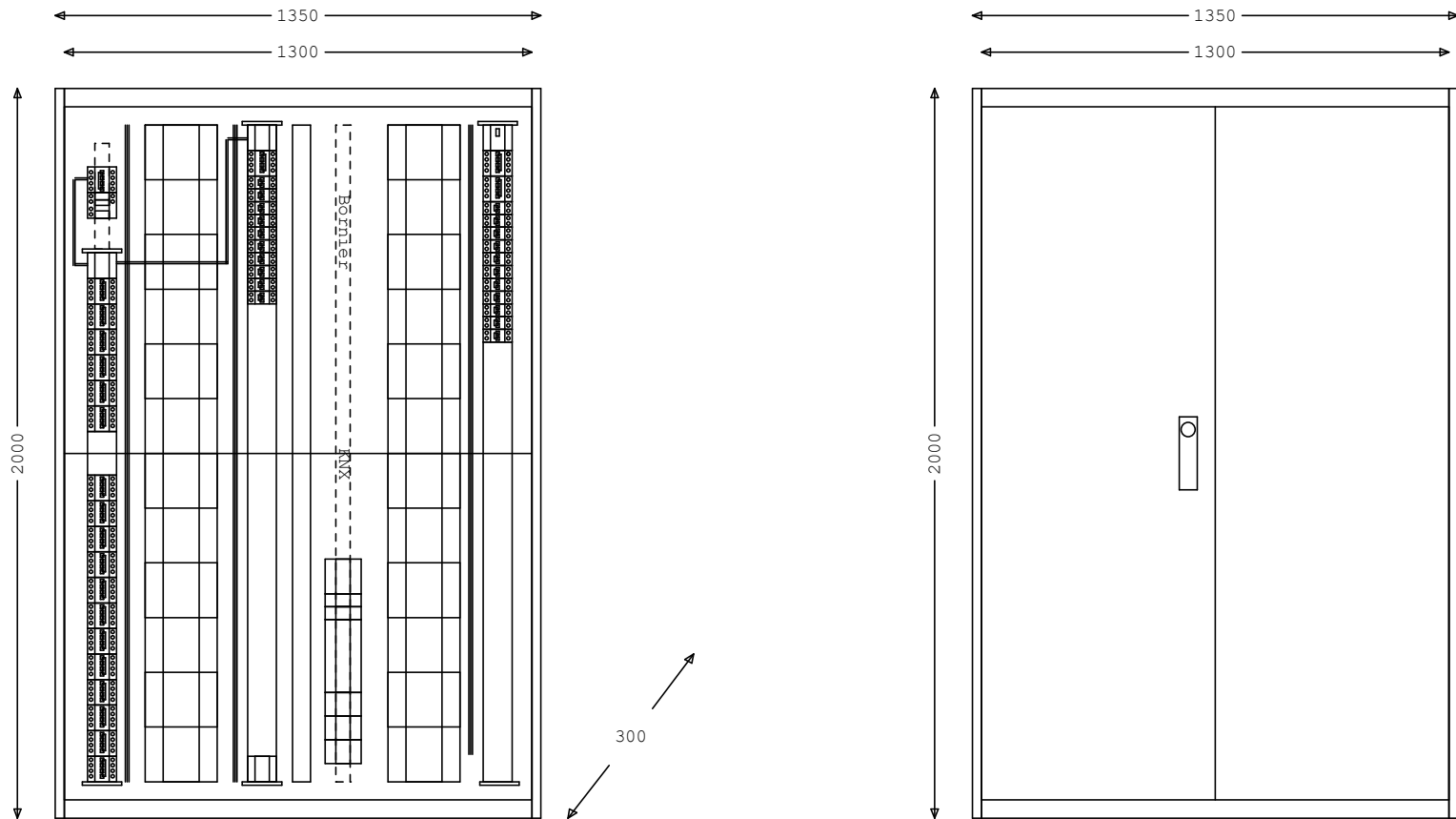

Ind.	Modif.	Date	Nom	Date	25.01.2022	Meyrin - Agilent	 TABELCO SA <small>Construction de tableaux électriques</small>	Tabelco SA		Rue Pierre Yerly 4		N° folio 2	
A	Creation	01.02.22	MAG	Resp.	MAG			1762 Givisiez		026/460.85.30		Préc.	Suiv.
											1		2